

# TECNIMETAL

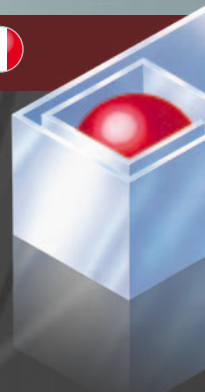

**PROTEZIONI TELESCOPICHE**  
**TELESCOPIC WAY COVERS**  
**TELESKOPABDECKUNGEN**  
**PROTECTEURS TÉLESCOPIQUES COMPOSANTS**

## PROFILO TECNIMETAL

TECNIMETAL, con sede in S. Giovanni in Croce - Cremona, operante nella costruzione di articoli tecnici per macchine utensili dal 1974, è costantemente impegnata nella ricerca e nelle innovazioni produttive, unitamente ad una tradizione di qualità ed affidabilità, che ha determinato un progressivo sviluppo dell'azienda ed una sua affermazione nel mercato nazionale ed internazionale.

Esperienza, specializzazione e conoscenza delle problematiche dei clienti, sono il fondamento dell'ufficio tecnico.

I più avanzati strumenti di calcolo e progettazione, danno luogo a nuovi layout di prodotti, che offrono soluzioni tecniche mirate alle diverse esigenze.

I nostri tecnici sono al servizio del cliente dalla fase iniziale dello studio di un progetto fino alla fase della messa in servizio.

Lavorando prevalentemente su commessa, l'azienda ha sviluppato una flessibilità tale che le permette di costruire nella sua gamma di prodotti, qualsiasi tipo di attrezzatura speciale, nel settore della macchina utensile.

All'interno dello stabilimento si sviluppa l'intero ciclo produttivo che parte dalle materie prime ed arriva al prodotto finito.

La produzione "TECNIMETAL" comprende i seguenti articoli:

- Protezioni a soffietto;
- Protezioni a nastro;
- Convogliatori di trucioli;
- Protezione telescopiche in lamiera d'acciaio speciale;
- Catene portacavi;
- Protezioni telescopiche a spirale;
- Raschiaolio in barre e sagomati;
- Protezioni a tapparella.

L'accurata selezione dei materiali titolati, la professionalità del personale, le avanzate tecniche produttive e la serietà commerciale sono le ragioni del successo TECNIMETAL.

Un successo che trova riscontro nelle numerose macchine ed impianti operanti in Italia e in tutto il mondo.

**TECNIMETAL, la scelta dell'affidabilità.**



## TECNIMETAL PROFILE

*TECNIMETAL, headquartered in S. Giovanni in Croce - Cremona, has been a top manufacturer of machine tool accessories since 1974, and is constantly engaged in research and product innovation, together with a tradition of quality and reliability, which has propelled TECNIMETAL's progressive expansion into the national and international markets.*

*Experience, specialization, and a clear understanding of costumers concerns are the basis of the technical department.*

*Advanced calculation and design instruments give rise to new products, which offer technical solutions for a vast number of requirements.*

*Our Technicians keep client concerns and needs in mind from the beginning of a design study to the actual installation of the equipment.*

*Working primarily on custom-made products, our company is among the most versatile in the world, allowing us to design and manufacture nearly any kind of special equipment in the machine tools field.*

*TECNIMETAL's range includes the following products:*

- Bellow covers;
- Roll up covers;
- Chip conveyors;
- Steel telescopic way covers;
- Cable carriers;
- Helical metal spring guards;
- Way wipers;
- Apron covers.

*The accurate selection of high quality materials, the close attention to detail, and the flexibility of our customer solutions, compounded by our professional and curteous staff and commercial dedication, make TECNIMETAL a leader of the industry. Our expertise in equipment design, manufacture and implementation can be found in installations throughout Italy and the rest of the world.*

**TECNIMETAL is the choice of reliability.**



## INDICE

INDEX



### PROTEZIONI A NASTRO

*STEEL TELESCOPIC WAY COVERS*

*TELESKOPABDECKUNGEN AUS STAHL*

*PROTECTEURS TELESCOPIQUES EN TOLE D'ACIER*

5

### PROTEZIONI TELESCOPICHE - ANALISI COMPONENTI

*TELESCOPIC WAYCOVERS - COMPONENTS REVIEW*

*TELESKOPABDECKUNGEN - BAUTEILEDDETAIL*

*PROTECTEURS TELESCOPIQUES - DETAIL DES COMPOSANTS*

6

### PROTEZIONI TELESCOPICHE AD ALTA VELOCITÀ MULTI SPEED TOTAL

*HIGH SPEED TELESCOPIC WAY COVERS MULTI SPEED-TOTAL*

*HOCHGESCHWINDIGKEITSTELESKOPABDECKUNGEN*

*PROTECTEURS TELESCOPIQUES A GRANDE VITESSE*

8

### PROTEZIONI TELESCOPICHE AD ALTA VELOCITÀ MULTI SPEED-MODULAR

*HIGH SPEED TELESCOPIC WAY COVERS MULTI SPEED-MODULAR*

*HOCHGESCHWINDIGKEITSTELESKOPABDECKUNGEN*

*PROTECTEURS TELESCOPIQUES A GRANDE VITESSE*

10

### PROTEZIONI TELESCOPICHE AD ALTA VELOCITÀ MULTI SPEED-UNISPACE

*HIGH SPEED TELESCOPIC WAY COVERS MULTI SPEED-UNISPACE*

*HOCHGESCHWINDIGKEITSTELESKOPABDECKUNGEN*

*PROTECTEURS TELESCOPIQUES A GRANDE VITESSE*

12

### SISTEMA DI MONTAGGIO DELLE PROTEZIONI TELESCOPICHE

*ASSEMBLY POSITION OF TELESCOPIC WAY COVERS*

*ANBAUSYSTEM DER TELESKOPABDECKUNGEN*

*SYSTEME DE MONTAGE DES PROTECTEURS TELESCOPIQUES*

14

### FORME STANDARD

*STANDARD SHAPES*

*STANDARDFORMEN*

*FORMES STANDARD*

17



## PROTEZIONI TELESCOPICHE IN LAMIERA D'ACCIAIO

STEEL TELESCOPIC WAY COVERS

TELESKOPABDECKUNGEN AUS STAHL

PROTECTEURS TELESCOPIQUES EN TOLE D'ACIER

### CARATTERISTICHE

L'esigenza di ottenere una precisione sempre maggiore e di conservare questa caratteristica per lungo tempo, impone ai costruttori di macchine utensili l'utilizzo di protezioni per viti e bancali.

TECNIMETAL ha messo a punto, sulla base di una lunga esperienza nel settore specifico e di una continua ricerca tecnica, una serie di coperture telescopiche metalliche in grado di proteggere viti e guide da elementi esterni che possono comprometterne l'efficienza e la durata.

Tali coperture costituiscono infatti un valido riparo contro sporcizia, trucioli, liquidi refrigeranti, emulsioni, urti accidentali di attrezzi o utensili, etc.

I materiali impiegati garantiscono ottima resistenza all'usura, agli agenti chimici, alla temperatura elevata.

Non bisogna infine dimenticare che le coperture telescopiche contribuiscono ad evitare infortuni sul lavoro e che portano un notevole beneficio alla macchina anche da un punto di vista puramente estetico.

### FEATURES

With the demand for ever increasing precision and the necessity to preserve this feature in time, the application of protective covers on lead screws and beds becomes indispensable to machine tools builders.

TECNIMETAL has implemented a range of telescopic way covers on the basis of a long experience and technical research, which are an ideal cover solution for machine tools' rails and lead screws, keeping their efficiency and prolonging their life.

Besides our telescopic covers are indeed an effective shield against dirt, red-hot debris, coolants, emulsions, fortuitous shocks produced by tools or instruments.

The utilized materials ensure excellent resistance to wear, chemical agents and high temperature.

You should be also reminded on the fact that telescopic covers contribute to reduce workplace injuries and also bring benefits related to machines aesthetics.

### EIGENSCHAFTEN

Um eine immer höhere Präzision zu haben und sie auch lange zu erhalten, ist es für die Hersteller von Werkzeugmaschinen unerlässlich, Schutzen für Spindeln und Führungen zu verwenden.

Auf Grund einer langjährigen Erfahrung im spezifischen Bereich und einer ununterbrochenen technische Forschung, hat Tecnimetal eine ganze Reihe von metallische Teleskopabdeckungen, die Schrauben und Führungen von Fremdkörpern schützen. Diese Fremdkörpern können die Leistung und Lebensdauer von Führungen und Fremdkörpern gefährden.

Solche Abdeckungen schützen eben von Schmutz, Spänen, Kühlflüssigkeiten, Emulsionen, zufälligen Anstossen von Werkzeuge usw. Die verwendeten Werkstoffe garantieren eine optimale Beständigkeit gegenüber chemischen Mitteln, Verschleiss, hohe Temperatur. Nicht zuletzt können die Teleskopabdeckungen Arbeitsunfälle vermeiden und bringen an der Maschine ein wesentliches besseres Aussehen.

### CARACTÉRISTIQUES

L'exigence d'une précision de plus en plus importante et le besoin de conserver cette caractéristique dans le temps, impose aux constructeurs de machines-outils l'emploi de protecteurs pour vis et chariots.

TECNIMETAL a mis au point grâce à une longue expérience dans le secteur spécifique et à une étude technique continue, une série de protecteurs télescopiques métallique à même de protéger les vis et les bancs d'élévations extérieurs pouvant en compromettre l'efficacité et la durée.

Ces protecteurs constituent en effet une protection valable contre la poussière, les copeaux, les liquides réfrigérants, les émulsions, les chocs accidentels d'outils, etc. Les matériaux utilisés garantissent une excellente résistance à l'usure, aux agents chimiques, aux températures élevées.

Enfin, il ne faut pas oublier que les protecteurs télescopiques contribuent à éviter des accidents sur le travail et qu'ils apportent un remarquable bénéfice à la machine même du point de vue purement esthétique.



## PROTEZIONI TELESCOPICHE - ANALISI COMPONENTI

TELESCOPIC WAYCOVERS - COMPONENTS REVIEW

TELESKOPABDECKUNGEN - BAUTEILEDDETAIL

PROTECTEURS TELESCOPIQUES - DETAIL DES COMPOSANTS

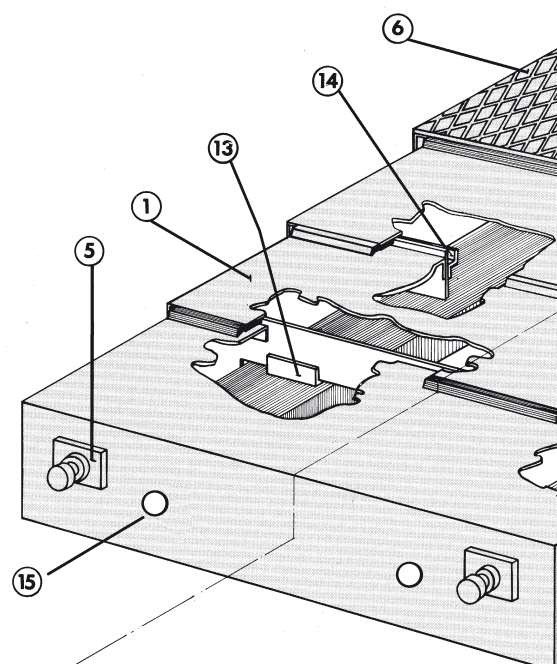
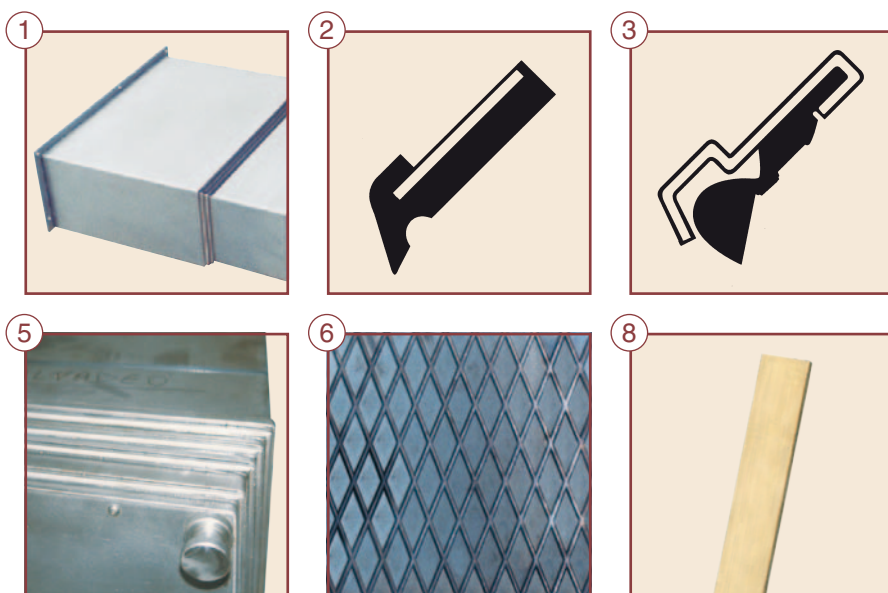

## ANALISI COMPONENTI

### ① ELEMENTI

Il materiale normalmente impiegato per la loro fabbricazione è una speciale lamiera di acciaio lucida prodotta su nostre specifiche tecniche negli spessori di 15/10, 20/10, 25/10 e 30/10.

Qualora particolari condizioni di impiego lo richiedano, può essere utilizzato acciaio inox.

Le lavorazioni alle quali questi materiali vengono sottoposti unitamente ad una opportuna conformazione, conferiscono agli stessi quelle caratteristiche di rigidità e indeformabilità che sono garanzia di efficienza e durata.

### ② ③ ⑦ RASCHIAOLIO

Sono realizzati in gomma antiolio o in poliuretano e vengono fissati sul bordo superiore dei cassoni e, se necessario, anche sui lati.

La sagoma opportunamente studiata, l'elasticità e la stabilità del materiale impiegato consentono di ottenere in qualsiasi circostanza l'assoluta pulizia interna delle nostre coperture. Sono previsti lamierini di protezione dei raschiatori per particolari condizioni d'impiego.

### ③ RASCHIAOLIO CON LAMIERINO DI PROTEZIONE

### ⑤ BORCHIE DI SOLLEVAMENTO

Ne sono provviste le coperture di peso superiore ai 100 Kg.

Servono per il montaggio sulla macchina e in seguito possono essere smontate.

### ⑥ RIVESTIMENTO ANTISCIVOLO

Consente di poter utilizzare la superficie superiore del cassone più grande per appoggiarvi attrezzi e utensili.

Può essere realizzato in lamiera striata.

### ⑧ LARDONI DI GUIDA LATERALI

In ottone evitano il grippaggio degli elementi.

### ⑨ PIEGA INFERIORE

Qualora non vi siano problemi di spazio, i cassoni presentano una ribordatura nella parte inferiore, che permette di ottenere un precarico sul labbro del raschiatore consentendone la perfetta aderenza alla superficie superiore del cassone successivo.

Dove non sia possibile avere la ribordatura inferiore, l'aderenza tra raschiatore e cas-

sone viene affidata o al peso dei cassoni stessi o speciali accorgimenti interni.

### ⑩ FLANGIA DI BLOCCAGGIO

### ⑪ PARACOLPO

### ⑫ CUSCINETTI A RULLI D'ACCIAIO

Vengono utilizzati nelle coperture di peso con velocità superiore ai 15mt. In questo caso, se le guide della macchina non hanno sufficiente durezza superficiale, è necessario predisporre apposite piste.

### ⑫b PATTINI GUIDA

Vengono utilizzati nelle coperture di peso contenuto con velocità inferiore ai 15 mt. Appoggiano direttamente sulle guide della macchina e sono costruiti in ottone con un riporto di materiale plastico antifrizione sulla superficie di contatto.

### ⑬ PATTINI GUIDA

### ⑭ CANALINE DI RECUPERO LIQUIDI

### ⑮ FORI PER BARRE DI SOLLEVAMENTO

Ne sono provviste le coperture di peso superiore ai 300 Kg.

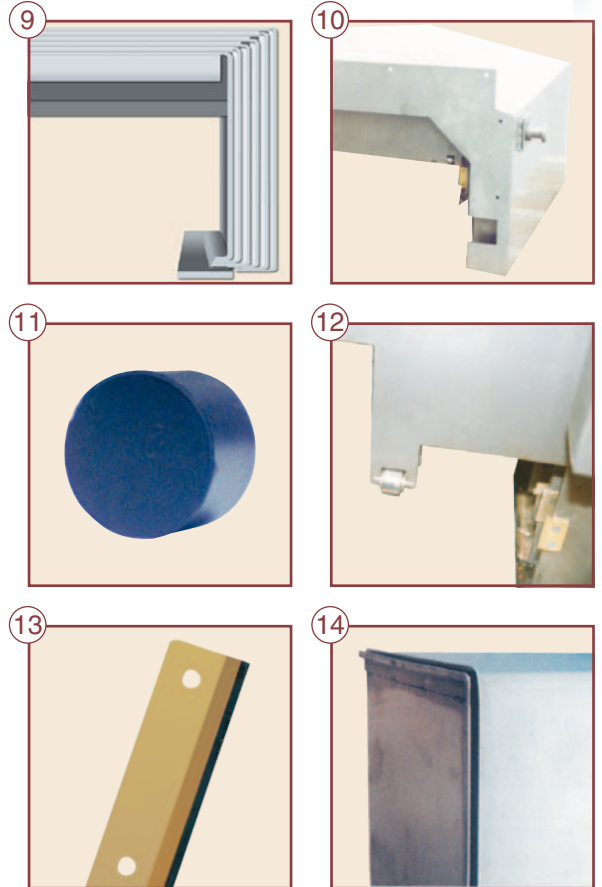
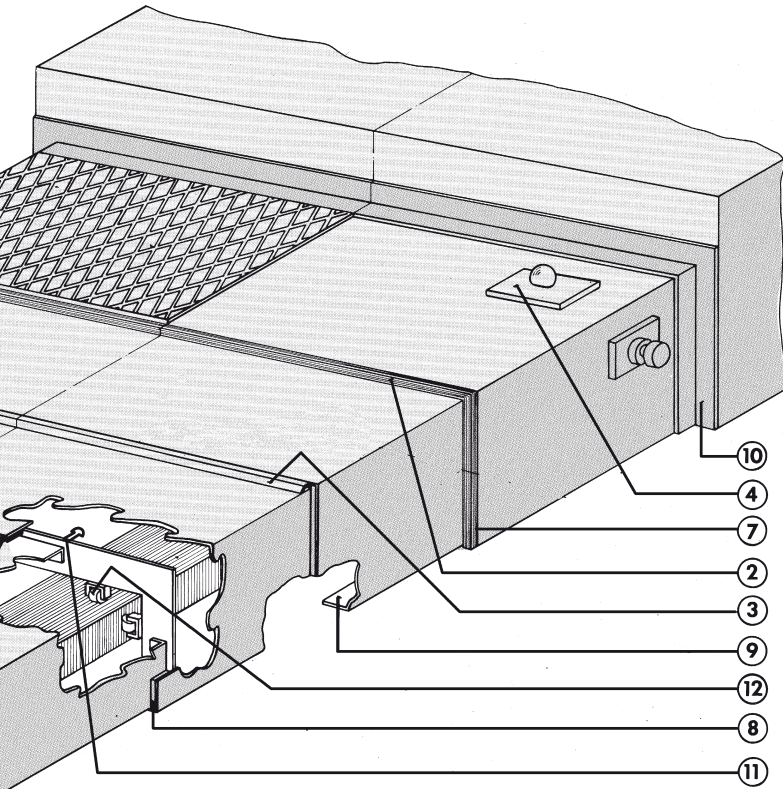

## COMPONENTS REVIEW

### ① BOXES

The material normally used to manufacture the boxes is a special, polished steel plate produced upon technical requirements in the following thicknesses: 1.5, 2.0, 2.5, and 3 mm.

Should special working conditions require it, stainless steel may also be used. Our high standards of machining combined with the tested design of our way covers guarantee superb rigidity and durability in the most demanding situations.

### ② ③ ⑦ WIPERS

They are made of oil-proof rubber or polyurethane and are fastened to the upper edge of the boxes and, if necessary, on the sides as well. The special design, the elasticity and the stability of the material, assure absolute internal cleanliness of our covers under any circumstances. For particular working conditions, wiper protection cases are provided.

### ③ WIPER WITH METAL PROTECTION

### ⑤ LIFTING LUGS

Covers weighing more than 100kg are

equipped with lifting lugs to facilitate machine assembly and can afterwards be removed.

### ⑥ ANTI-SKID TREAD PLATE

This plate can be used as a convenient area to place tools or other instruments on the largest of the way covers boxes, and is offered in checkered plate.

### ⑧ SIDE GUIDING GIBS

They are made of brass and are secured to the edges of each box, avoiding seizure.

### ⑨ LOWER BENDING

Whenever enough room is available, boxes are provided with a wrap around edge at the bottom, determining a preload effect on the wiper lip, making a perfect adherence on the box which is located beneath. In case that would not be possible the adhesion between the wipers and the boxes is supplied by the weight itself or special devices placed inside the way cover.

### ⑩ FASTENING PLATE

### ⑪ SCHOCK ABSORBER

### ⑫ STEEL NEEDLE BEARINGS

Steel Needle Bearings are used to facilitate movement of way covers operating at speeds greater than 15 mts/min, preventing the rupture of the railing. Careful and correct installation is advised.

### ⑬ SLIDING SHOES

Used on way covers operating at speeds less than 15 mts/min and rest directly on the machines slide-ways. They are made of brass coated with plastic and an anti-friction material on the contact surface.

### ⑬ BRASS SLIDER COATED WITH ANTI-FRICTION MATERIAL

### ⑭ COOLANT DRAIN GUTTER

### ⑮ HOLES FOR LIFT RODS

Covers over 300kg in weight are equipped with lift rods, which facilitate the movement of the way cover for purposes of assembly. The lift rods can afterwards be removed.

## PROTEZIONI TELESCOPICHE AD ALTA VELOCITÀ MULTI SPEED TOTAL

HIGH SPEED TELESCOPIC WAY COVERS MULTI SPEED-TOTAL

HOCHGESCHWINDIGKEITSTELESKOPABDECKUNGEN

PROTECTEURS TELESCOPIQUES A GRANDE VITESSE

### CARATTERISTICHE

La velocità e l'accelerazione sono elementi importanti per il successo di una macchina utensile. Con l'avvento dei motori lineari si sono raggiunti traguardi un tempo impensabili.

Tecnimetal ha seguito questa evoluzione investendo molte energie nel settore delle protezioni telescopiche applicate a queste nuove realtà.

Multispeed è la risposta sicura e completa a tutte queste nuove esigenze.

I modelli che proponiamo sono i seguenti:

- MULTI SPEED-TOTAL
- MULTI SPEED-MODULAR
- MULTI SPEED-UNISPACE

#### MULTI SPEED-TOTAL

Sono consigliate per proteggere unità di piccola, media dimensione aventi corse di 3.000 mm al massimo.

Velocità massime raggiungibili di 120 mt./min.

Accelerazione massima 2G.

Rumorosità massima 40 Decibel.

Sistema di trazione a pantografi (vedi foto pag. 9)

Gli elementi di questa protezione si muovono tutti contemporaneamente e uniformemente.

### FEATURES

As machine builders increased travel velocities and accelerations to meet demands for increased productivity, with the coming of linear motors covers performance and reliability have become even more critical.

Tecnimetal is meeting these challenges quickly investing in people, equipment and technology to insure that our telescopic covers meet these specifications, and Multi Speed is a complete and liable answer to these requirements.

Following versions are available:

- MULTI SPEED-TOTAL
- MULTI SPEED-MODULAR
- MULTI SPEED-UNISPACE

#### MULTI SPEED-TOTAL

This unique waycover is recommended for protecting units with strokes up to 3000 mm, with a maximum operating speed of 120mt/min and maximum acceleration of 2 G,s, maximum noise rate of 40 decibels, traction device has pantographs (see picture on page 9). The boxes of this way cover extend and contract together at the same time.

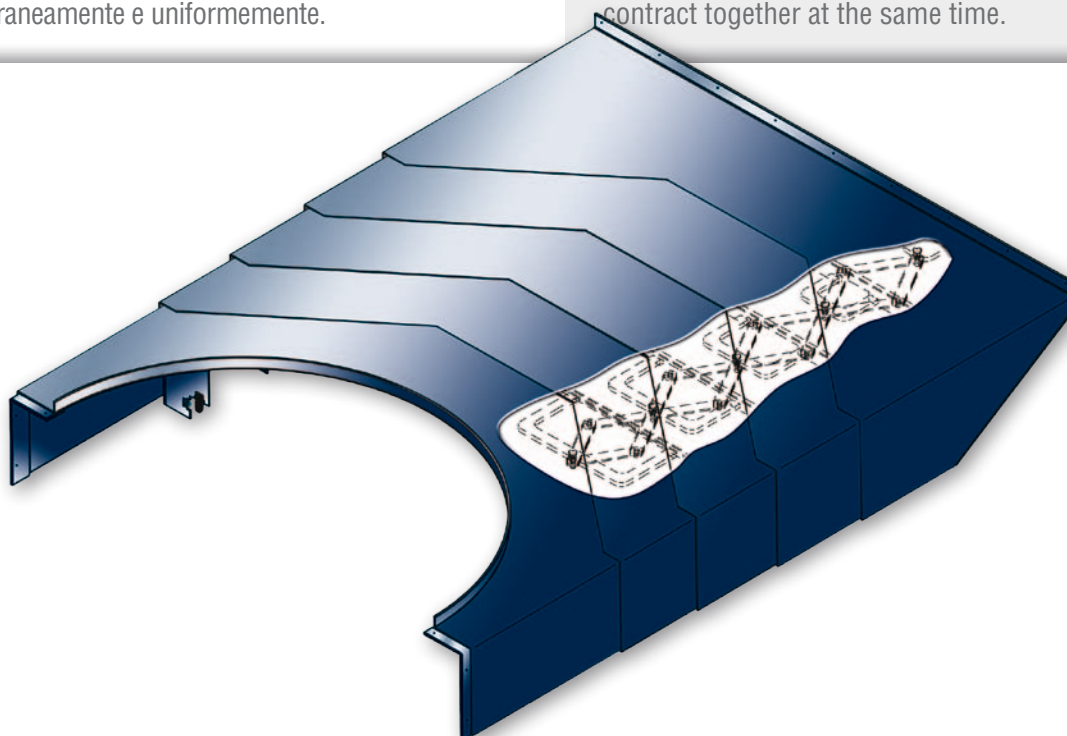



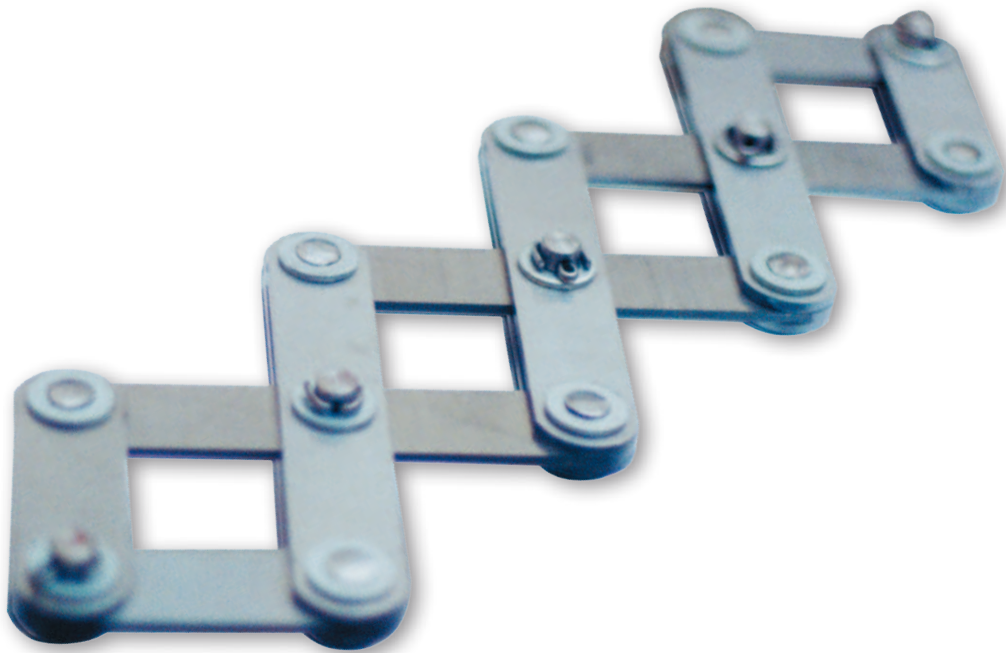

## EIGENSCHAFTEN

Geschwindigkeit und Beschleunigung sind wichtige Eigenschaften für den Erfolg der Werkzeugmaschinen. Der Anbruch der Reihenmotoren hat man Ziel, einst undenkbar, erreicht.

Tecnimetal hat diese Entwicklung gefolgt und hat Zeit für die Nutzanwendung dieser neuen Realitäten an den Teleskopabdeckungen eingesetzt.

Multi Speed ist die zuverlässige und komplette Antwort auf diesen neuen Erfordernis.

Die vorgeschlagene Modelle sind die folgende:

- MULTI SPEED-TOTAL
- MULTI SPEED-MODULAR
- MULTI SPEED-UNISPACE

### MULTI SPEED-TOTAL

Dieses Modell ist geeignet für Maschinen, die kleine und medium dimension haben, mit Hub bis zu max. 3000 mm.

Maximal erreichbare Geschwindigkeit 2G.

Maximaler Geräusch 40 Decibel.

Antriebssystem (siehe Bild Seite 8-9)

Die Elemente dieser Abdeckung bewegen sich gleichzeitig und gleichmäßig.

## CARACTÉRISTIQUES

Vitesses et accélérations sont des caractéristiques importantes qui influencent le choix d'une machine-outil. L'introduction des moteurs linéaires a permis d'atteindre des objectifs impensables auparavant. Tecnimetal a suivi cette évolution en plaçant beaucoup d'énergie dans le développement des protecteurs télescopiques pour répondre à ces nouvelles réalités. Multi speed est la solution adaptée et conforme à ces nouvelles demandes.

Les modèles proposés sont les suivants:

- MULTI SPEED-TOTAL
- MULTI SPEED-MODULAR
- MULTI SPEED-UNISPACE

### MULTI SPEED-TOTAL

Ces protecteurs sont employés pour la protection d'une unité de petite ou moyenne dimension ayant une course maxi de 3000 mm.

Vitesse: 120 mt./min. maxi

Accélération: 2 G maxi

Bruit: 40 décibels maxi

Système de traction par ciseaux (voir photos pages 8-9).

Les tôles de ces protecteurs bougent toutes en même temps et uniformément.

## PROTEZIONI TELESCOPICHE AD ALTA VELOCITÀ MULTI SPEED-MODULAR

HIGH SPEED TELESCOPIC WAY COVERS MULTI SPEED-MODULAR

HOCHGESCHWINDIGKEITSTELESKOPABDECKUNGEN

PROTECTEURS TELESCOPIQUES A GRANDE VITESSE

### CARATTERISTICHE

#### MULTI SPEED-MODULAR

Si applica a macchine utensili di grandi dimensioni con corse superiori a 3.000 mm. e guide con larghezze fino a 5.000 mm.

Velocità massime raggiungibili di 60 mt./min.

Accelerazione da 8/20 m. sec. Quadro.

Rumorosità massima 50 Decibel.

Sistema di trazione a doppio ammortizzatore incrociato ed imperniato. Al centro ogni ammortizzatore è composto da due martinetti a doppio effetto brevetto-Tecnimetal (vedi foto pag 10/11).

Multi Speed-Modular consente di aprire e chiudere la protezione senza scosse ed urti violenti. Gli elementi scorrono sulle guide in modo indipendente e modulare grazie al traino garantito dal nostro brevetto. Da notare che l'applicazione di questo sistema non richiede spazi superiori alle protezioni tradizionali.

### FEATURES

#### MULTI SPEED-MODULAR

This way cover is advised for protecting units with strokes greater than 3000 mm., and railings wide up to 5000 mm. with a maximum operating speed of 60 mt./min. and maximum acceleration of 8/20 mt./sq.sec.

Maximum noise rate of 50 dec.

Traction device is consisting of double hinged damper, which is made up of two jacks in the middle with double effect, patented by Tecnimetal (see picture on page 10/11).

Multi Speed-Modular system allows way covers to extend and contract without shocks and forceful bumps.

Boxes roll on the railings independently and modularly thanks to our patented traction device.

Please remark that this implementation will not require any further space than common way covers.

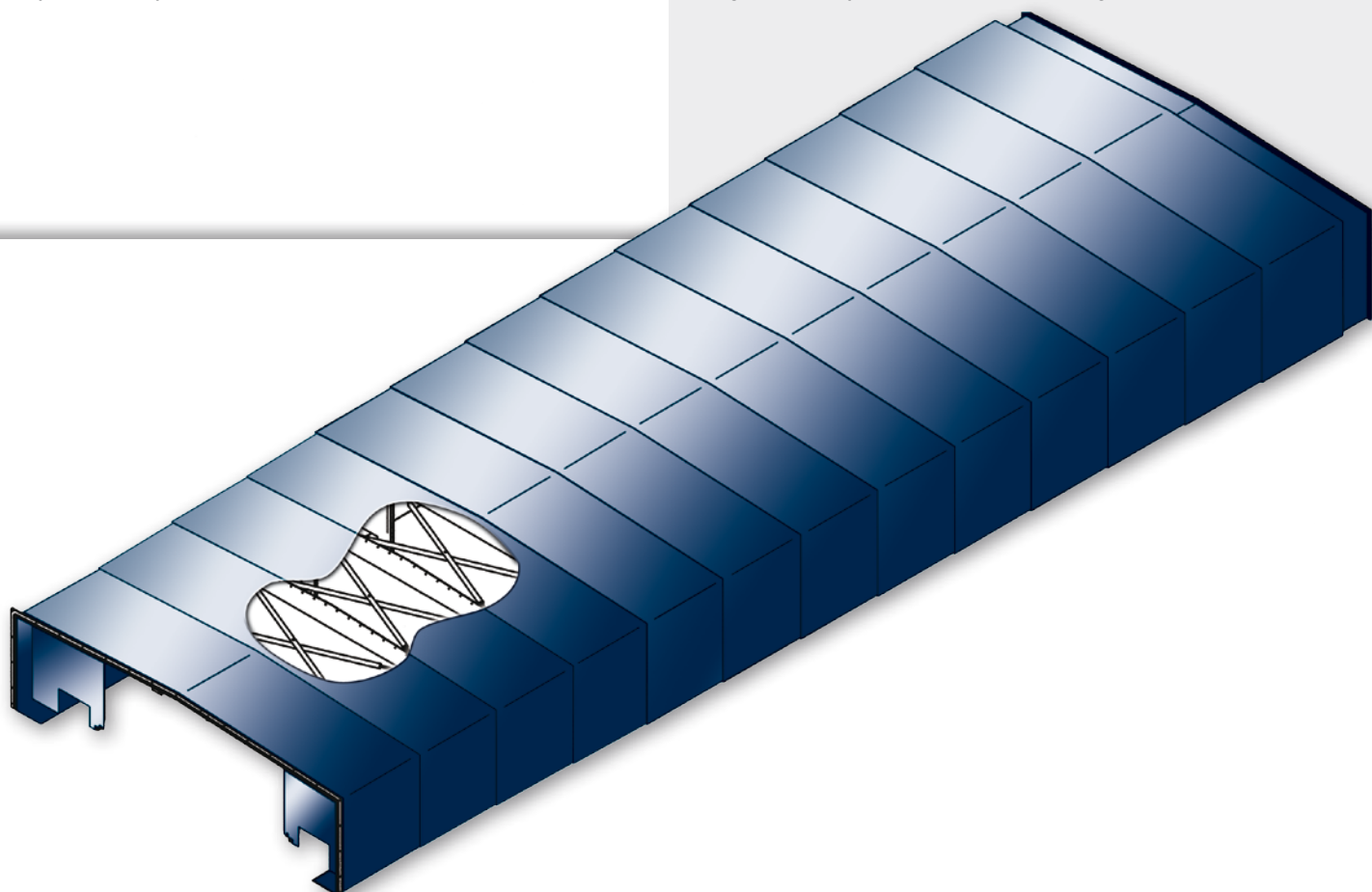

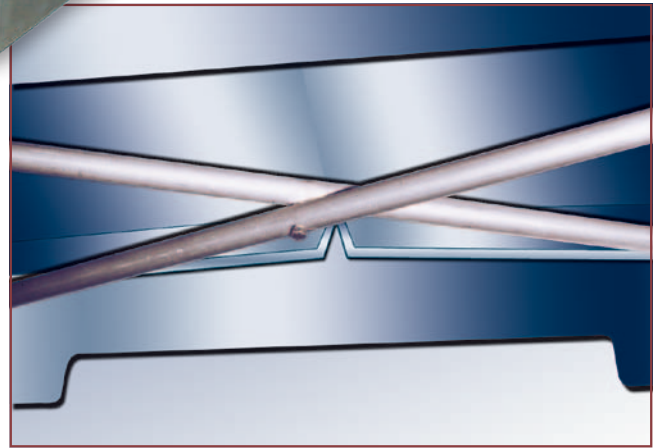
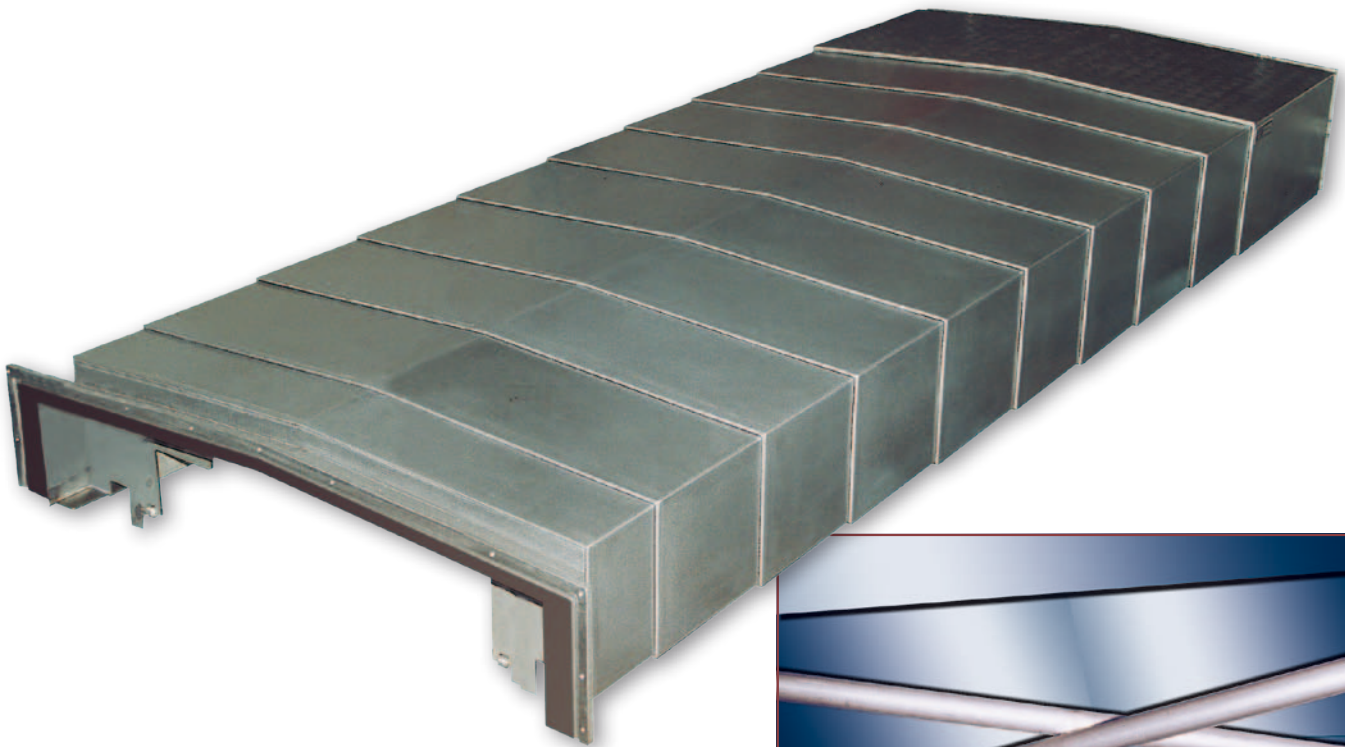

## EIGENSCHAFTEN

### MULTI SPEED-MODULAR

Man setzt an den grösse Maschinen mit Hub über 3000 mm. und Führungsbahnen bis zu 5000 mm breit ein. Maximal erreichbar Geschwindigkeit 60 mt/min. Beschleunigung 8-20 mt/sek<sup>2</sup>. Maximal Geräusch 50 Decibel. Antriebsschere mit doppelten, gekreuzt und verbolzt Dämpfer. In der Mitte, hat jede Dämpfer zwei Hebebock mit doppelter Wirkung, Tecnimetal Patent (siehe Bild seite 10-11). Multi Speed-Modular beistimmt die Teleskopabdeckung, ohne Ruck und gewalttätig Stoss zu öffnen. Die Elementen laufen selbstständig auf der Führungsbahnen und mit einer modulierte Bewegung, dank dem Schleppen, bei unserem Patent sichert. Es ist wichtig zu wissen, dass die Einsetzung diesem System keine grösserer Raum an der traditionelle Abdeckung benötigt.

## CARACTÉRISTIQUES

### MULTI SPEED-MODULAR

Ces protecteurs sont utilisés sur des machines de grandes dimensions ayant des courses supérieures à 3000 mm. et des glissières de largeur maxi 5000 mm. Vitesse: 60 mt./min. maxi Accélération: de 8-20 ms<sup>2</sup> Bruit: 50 décibels maxi Système de traction par amortisseurs doubles croisés et fixés par tourillons. Au centre de chaque amortisseur se trouvent deux vérins à double effet brevetés par Tecnimetal (voir photos pages 10-11). Multi Speed-Modular permet de déployer et de comprimer le protecteur sans secousses ni coups violents. Grace aux mouvements controlés et garantis par notre système breveté, les éléments bougent d'une façon indépendante et séquentielle. L'encombrement de ce système n'exige pas d'espace supplémentaire par rapport aux protecteurs traditionnels.

## PROTEZIONI TELESCOPICHE AD ALTA VELOCITÀ MULTI SPEED-UNISPACE

HIGH SPEED TELESCOPIC WAY COVERS MULTI SPEED-UNISPACE

HOCHGESCHWINDIGKEITSTELESKOPABDECKUNGEN

PROTECTEURS TELESCOPIQUES A GRANDE VITESSE

### CARATTERISTICHE

#### MULTI SPEED-UNISPACE

Si impiegano in situazioni dove lo spazio a disposizione è ridotto e dove non esistono guide per applicare una barriera di protezione.

Unispace può essere offerta in due versioni

LINEAR - movimento su un solo asse

ORBITAL - movimento universale orbitale.

In entrambi i casi la protezione è un monoblocco completo di guide e struttura portante che permettono l'applicazione alla macchina utensile con una semplice operazione di bloccaggio con viti.

Velocità massime raggiungibili di 120 mt./min.

Accelerazione massima 2G.

Rumorosità massima 40 Decibel.

Sistema di trazione Multi Speed-Total.

### FEATURES

#### MULTI SPEED-UNISPACE

This way cover version is suggested whenever the available space is small and no railings have been placed on the machines.

Unispace can be offered in two variants:

LINEAR - one axis movement

ORBITAL - universal orbital movement

In both cases this way cover is made up of a monoblock including rails and load bearing structure which can be fastened to the machine only by tightening some screws.

Maximum operating speed of 120 mts./min. and

Maximum acceleration of 2 G's, maximum noise rate of 40 decibels.

Traction device is multi-speed.



**MULTI SPEED-UNISPACE LINEAR**

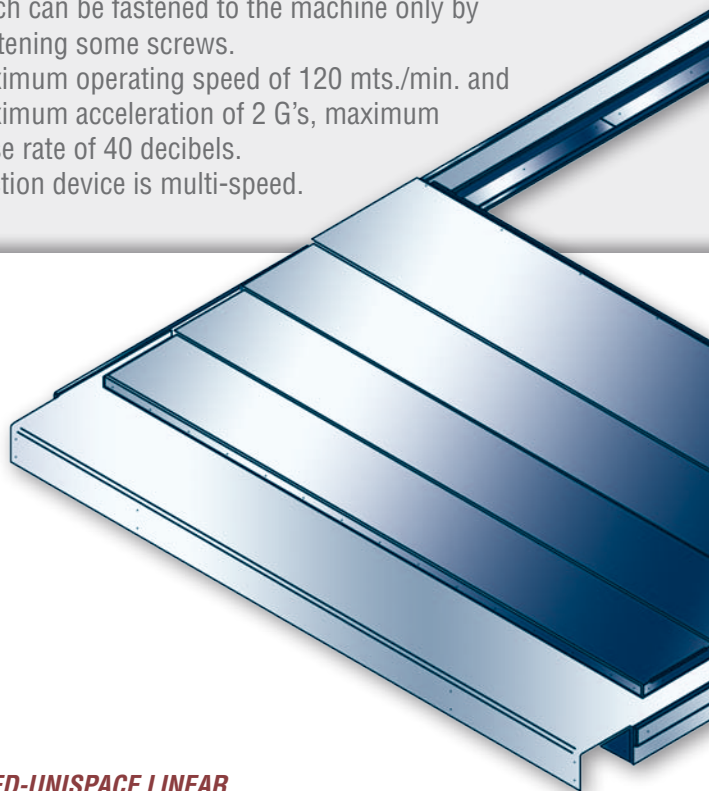

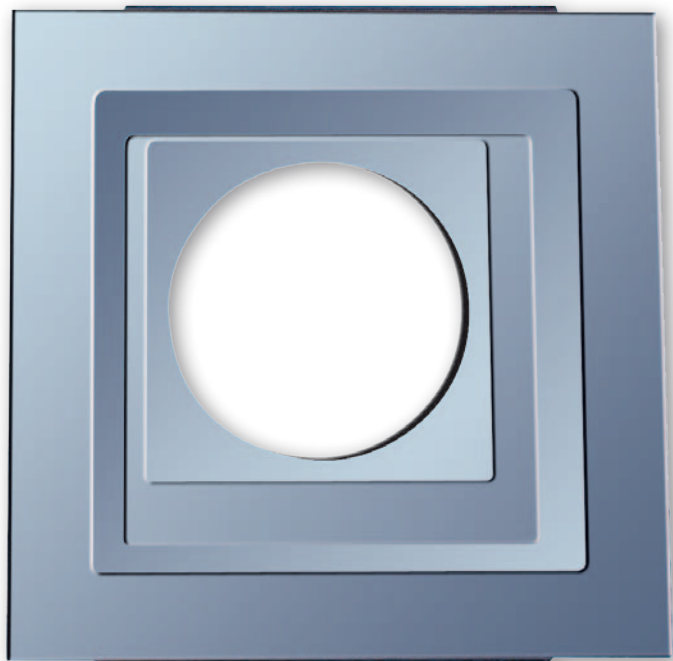

**MULTI SPEED-UNISPACE ORBITAL**

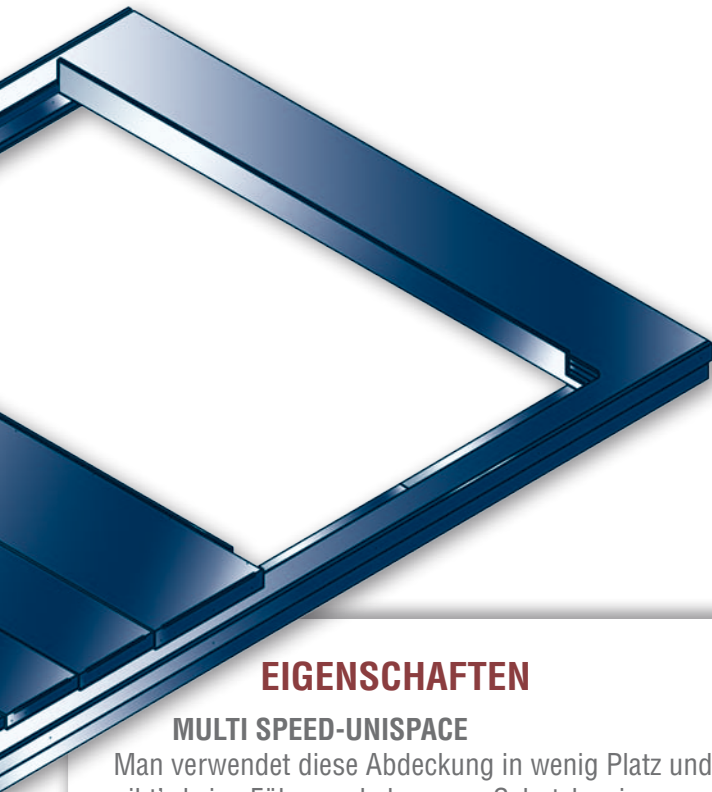

## EIGENSCHAFTEN

### MULTI SPEED-UNISPACE

Man verwendet diese Abdeckung in wenig Platz und gibt's keine Führungsbahnen wo Schutzbarriere zu einsetzen.

Unispace hat 2 Versionen:

LINEAR - Bewegung auf einer Achse.

ORBITAL - univeral Umlaufbewegung.

Die Abdeckung ist ein einzel Block komplett mit Führungsbahnen und Tragwerk, die die Einsetzung an der Werkzeugmaschine bei der Blockierung mit Schrauben ermoeeglicht.

Maximal erreichbar Geschwindigkeit 120 mt/min

Maximal Beschleunigung 2G

Maximal Geräusch 40 Decibel.

Multispeed total Spannung.

## CARACTÉRISTIQUES

### MULTI SPEED-UNISPACE

Ces protecteurs sont employés quand l'espace disponible est réduit et qu'il manque des glissières pour l'application d'une barrière de protection.

Unispace est proposé en deux versions:

LINEAR - mouvement sur un axe

ORBITAL - mouvement universel et orbital.

Dans les deux cas le protecteur est un monobloc pourvu de glissières et de structure portante facilitant le montage sur la machine - outils par le simple serrage de vis.

Vitesse: 120 mt./min. maxi

Accélération: 2 G maxi

Bruit: 40 décibels maxi

Système de traction multispeed total.

# SISTEMA DI MONTAGGIO DELLE PROTEZIONI TELESCOPICHE

ASSEMBLY POSITION OF TELESCOPIC WAY COVERS

ANBAUSYSTEM DER TELESKOPABDECKUNGEN

SYSTEME DE MONTAGE DES PROTECTEURS TELESCOPIQUES

## PROTEZIONE TELESCOPICA PIATTA TRASVERSALE • FLAT CROSS RAIL TELESCOPIC COVER FLACHE QUERE TELESKOPABDECKUNG • PROTECTEUR TELESCOPIQUE PLATE TRANSVERSALE

Forma 1.0 • Shape 1.0 • Form 1.0 • Forme 1.0

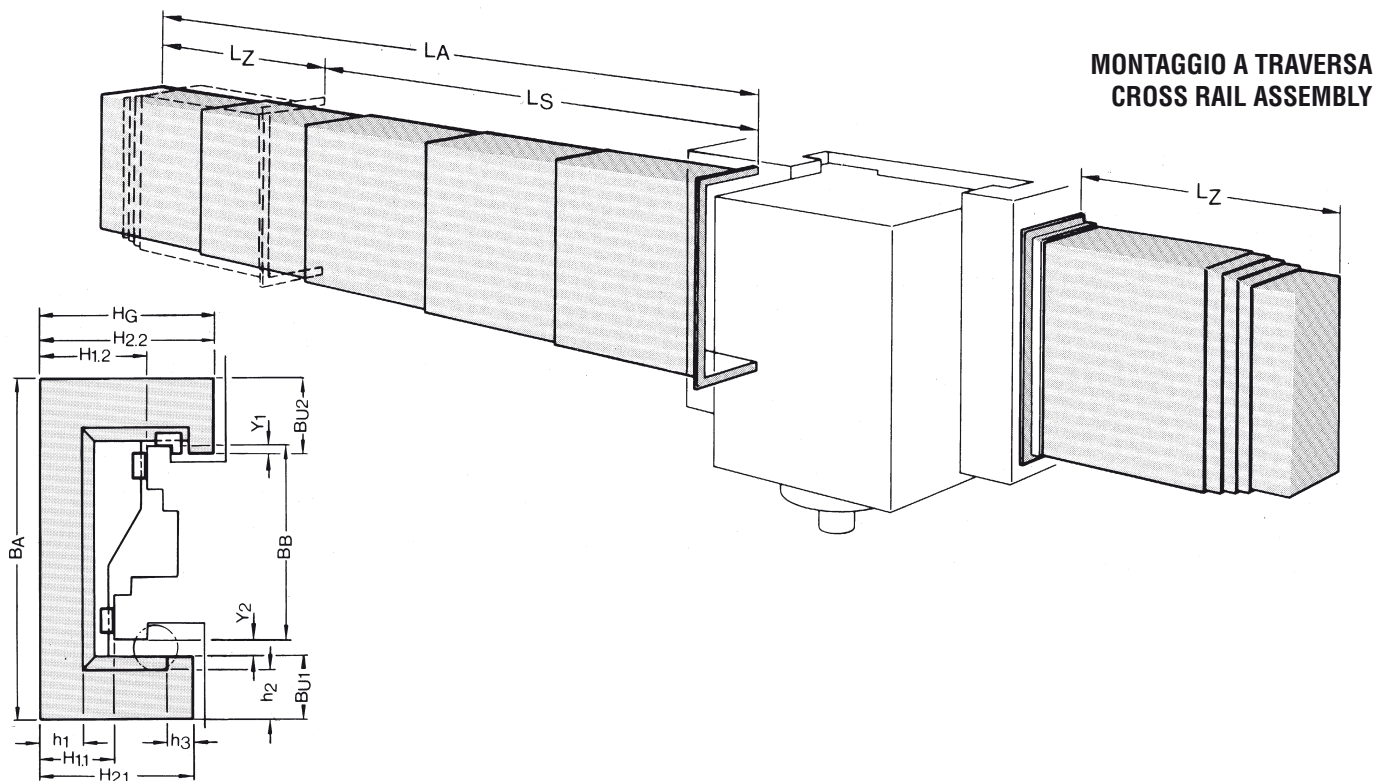

MONTAGGIO A TRAVERSA  
CROSS RAIL ASSEMBLY

### Forma scelta

come figura accanto

come forme standard

se  $Y1 < Y2$  montaggio frontale

se  $Y1 \geq Y2$  montaggio dall'estremità

Secondo la posizione del baricentro occorre prevedere ulteriori pattini di tenuta, fissi o avvitabili.

### Chosen shape

as shown in figure

as standard shapes

if  $Y1 < Y2$  front mounting

if  $Y1 \geq Y2$  end mounting

Depending upon the position of the barycentre, it will be necessary to provide further slide shoes, either fixed or detachable.

### Gewälte Form

wie das Bild nebenan

Standardform

bei  $Y1 < Y2$  Stirnmontage

bei  $Y1 \geq Y2$  Seitenmontage

Nach der Schwerpunktlage sind weitere feste bzw. anschraubbare Dichtgleiter erforderlich.

### Forme choisie

comme figure à côté

comme forme standard

si  $Y1 < Y2$  montage frontal

si  $Y1 \geq Y2$  montage à l'extrémité

Selon la position du centre de gravité il faut prévoir d'autres patins de tenue, fixes ou qu'on peut visser.



**PROTEZIONE TELESCOPICA PIATTA VERTICALE**  
**FLAT VERTICAL TELESCOPIC COVER**  
**FLACHE SENKRECHTE TELESKOPABDECKUNG**  
**PROTECTEUR TELESCOPIQUE PLATE VERTICALE**

Forma 1.0 • Shape 1.0 • Form 1.0 • Forme 1.0

**MONTAGGIO VERTICALE - VERTICAL ASSEMBLY**

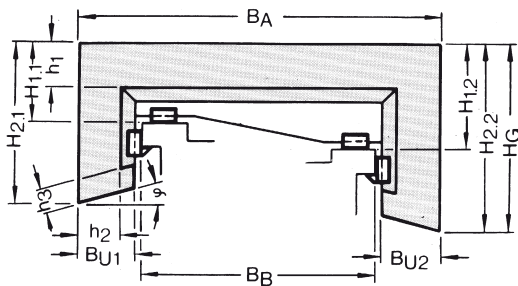

**Forma scelta**

- come figura accanto
- come forme standard

**Chosen shape**

- as shown in figure
- as standard shapes

**Forme choisie**

- comme figure à côté
- comme forme standard

**Gewälte Form**

- wie das Bild nebenan
- Standardform

Attacco superiore • Upper fastening plate  
 Anschluss oben • Joint supérieur

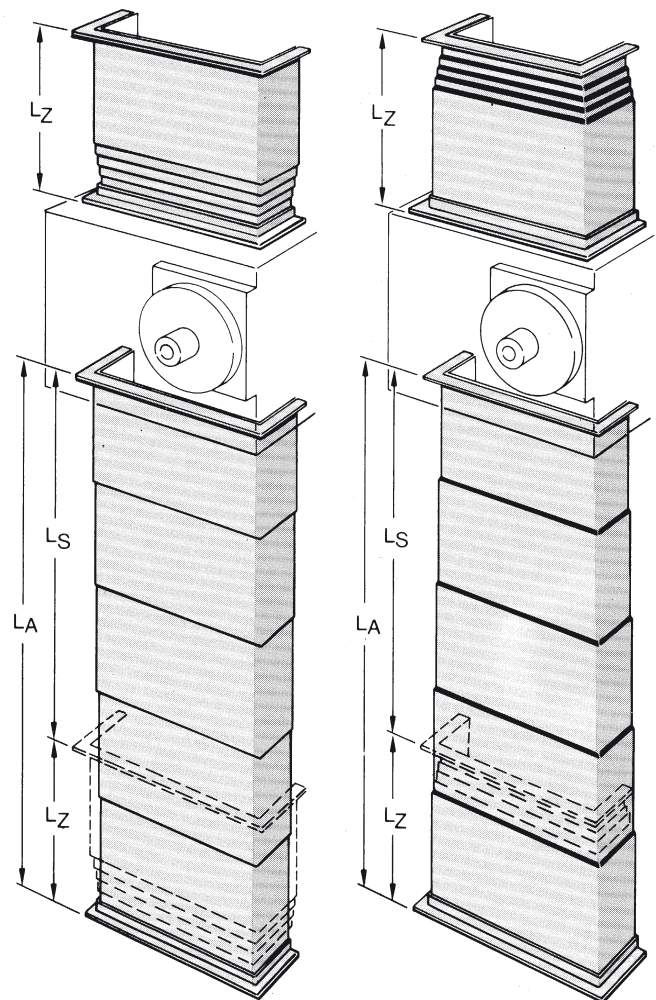

Attacco inferiore • Lower fastening plate  
 Anschluss unten • Joint inférieur

**PROTEZIONE TELESCOPICA PIATTA ORIZZONTALE • FLAT HORIZONTAL TELESCOPIC WAY COVER  
WAAGERECHTE FLACHE TELESKOPABDECKUNG • PROTECTEUR TELESCOPIQUE PLAT HORIZONTAL**

Forma 1.0 • Shape 1.0 • Form 1.0 • Forme 1.0

**MONTAGGIO ORIZZONTALE - HORIZONTAL ASSEMBLY**

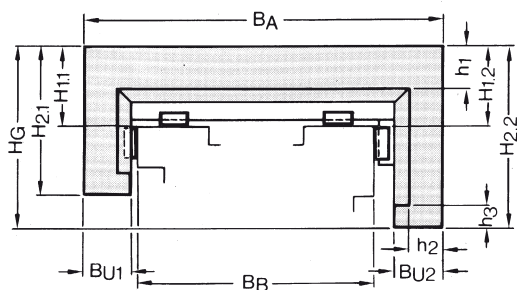
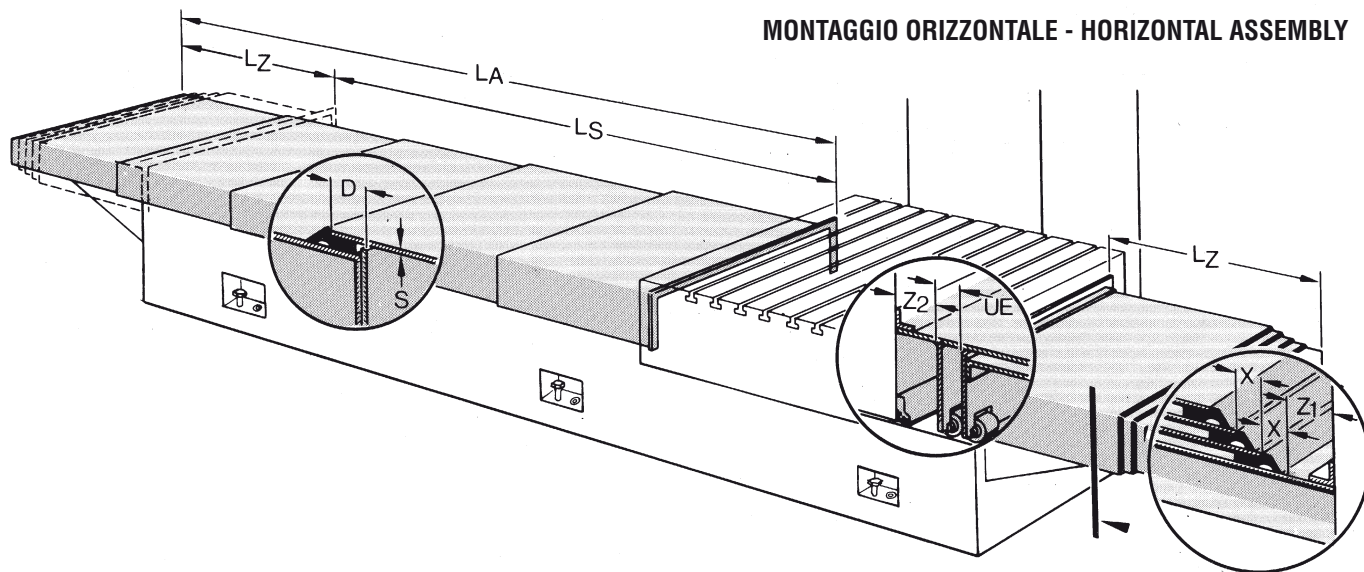

**Forma scelta**

- come figura accanto
- come forme standard

**Chosen shape**

- as shown in figure
- as standard shapes

**Forme choisie**

- comme figure à côté
- comme forme standard

**Gewälte Form**

- wie das Bild nebenan
- Standardform





## FORME STANDARD

STANDARD SHAPES  
STANDARDFORMEN  
FORMES STANDARD

### DESCRIZIONE

Le forma delle protezioni telescopiche viene scelta in base agli ingombri esistenti sulla macchina, alle condizioni di lavoro in relazione alla quantità di trucioli e di liquido refrigerante e ad accorgimenti estetici in conformità all'immagine completa della macchina.

### DESCRIPTION

Telescopic way covers design is developed on the basis of machines' overall dimensions, operating conditions, in relation to the amount of debris and coolants, and in accordance with the machine aesthetics.

### BESCHREIBUNG

Die Form der Teleskopabdeckungen entspricht den Abmessungen der Maschine, den Arbeitsbedingungen im Bezug auf der Spänmenge und kühlmittel nicht zuletzt sind ästhetische umsichte für eine gute Gesamtbild der Maschine.

### DESCRIPTION

On choisit la forme des protecteurs télescopiques sur la base des encombrements existant sur la machine, des conditions de travail en relation à la quantité de copeaux et de liquide réfrigérant et selon un critère esthétique en conformité à l'image de présentation de la machine.

### PROTEZIONE TELESCOPICA PIANA CON GUIDE IN OTTONE FRESATE

FLAT TELESCOPIC COVER WITH MILLED BRASS SLIDES

FLACHE TELESKOPABDECKUNG MIT GEFRÄSTEN  
FÜHRUNGEN AUS MESSING

PROTECTEUR TELESCOPIQUE PLATE  
AVEC GLISSIERES FRAISEES EN LAITON

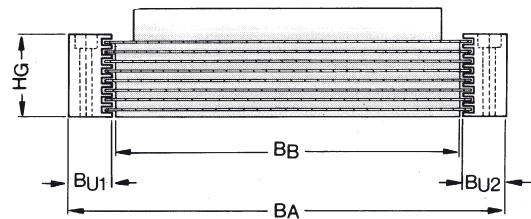

Forma • Shape • Form • Forme 2.0

### PROTEZIONE TELESCOPICA CON PENDENZA SINISTRA

TELESCOPIC COVER SLOPING TO THE LEFT

TELESKOPABDECKUNG LINKSNEIGUNG

PROTECTEUR TELESCOPIQUE INCLINE A GAUCHE

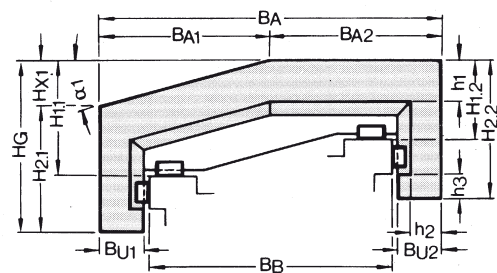

Forma • Shape • Form • Forme 2.1

**PROTEZIONE TELESCOPICA CON PENDENZA DESTRA**  
**TELESCOPIC COVER SLOPING TO THE RIGHT**  
**TELESKOPABDECKUNG MIT RECHTER NEIGUNG**  
**PROTECTEUR TELESCOPIQUE INCLINE A DROITE**

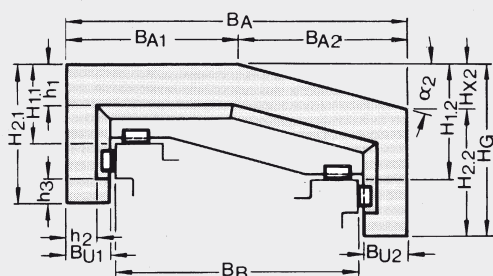

Forma • Shape • Form • Forme 2.2

**PROTEZIONE TELESCOPICA CON INCLINAZIONE SINISTRA**  
**TELESCOPIC COVER INCLINED TO THE LEFT**  
**TELESKOPABDECKUNG RECHTSNEIGUNG**  
**PROTECTEUR TELESCOPIQUE INCLINE A GAUCHE**

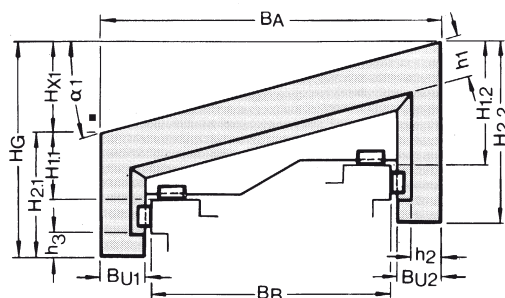

Forma • Shape • Form • Forme 3.1

**PROTEZIONE TELESCOPICA CON INCLINAZIONE DESTRA**  
**TELESCOPIC WAY COVER INCLINED TO THE RIGHT**  
**TELESKOPABDECKUNG RECHTSNEIGUNG**  
**PROTECTEUR TELESCOPIQUE INCLINE A DROITE**

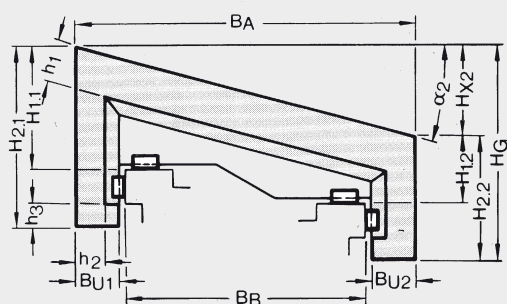

Forma • Shape • Form • Forme 3.2

**PROTEZIONE TELESCOPICA CON TETTO SIMMETRICA**  
**TELESCOPIC WAY COVER WITH SYMMETRIC ROOF**  
**DACH-TELESKOPABDECKUNG SYMMETRISCH**  
**PROTECTEUR TELESCOPIQUE EN FORME DE TOIT SYMETRIQUE**

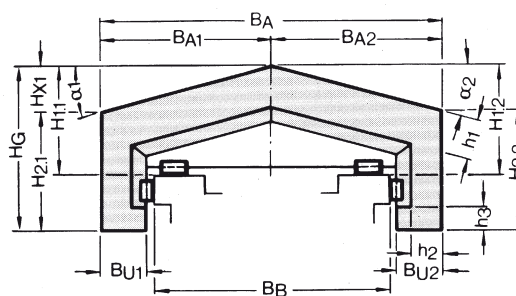

Forma • Shape • Form • Forme 4.0

**PROTEZIONE TELESCOPICA CON TETTO ASIMMETRICA**  
**TELESCOPIC WAY COVER WITH ASYMMETRIC ROOF**  
**ASYMMETRISCHE DACH-FÖRMIGE TELESKOPABDECKUNG**  
**PROTECTEUR TELESCOPIQUE EN FORME DE TOIT ASYMETRIQUE**

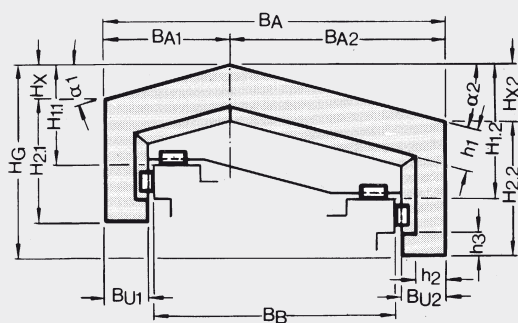

Forma • Shape • Form • Forme 5.0

**PROTEZIONE TELESCOPICA CON TETTO PIATTO SIMMETRICA**  
**TELESCOPIC WAY COVER WITH FLAT, SYMMETRIC ROOF**  
**SYMMETRISCHE DACH-FÖRMIGE TELESKOPABDECKUNG**  
**PROTECTEUR TELESCOPIQUE EN FORME DE TOIT SYMETRIQUE**

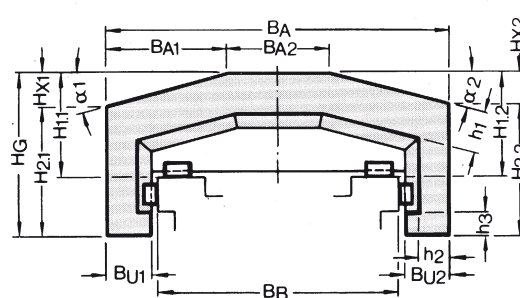

Forma • Shape • Form • Forme 6.0



**PROTEZIONE TELESCOPICA A PIEGHE MULTIPLE**  
**MULTIPLE BENDINGS WAY COVER**  
**TELESKOPABDECKUNG MIT VIELFÄLTIGEN**  
**PROTECTEUR TELESCOPIQUE A PLIAGE MULTIPLE**

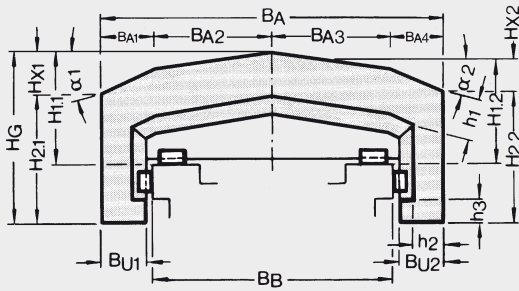

Forma • Shape • Form • Forme 6.1

**PROTEZIONE TELESCOPICA PER TORNIO TIPO 2**  
**LATHE MACHINE WAY COVER TYPE 2**  
**TELESKOPABDECKUNG FÜR DREHMASCHINE TYPE 2**  
**PROTECTEUR TELESCOPIQUE POUR TOUR TYPE 2**

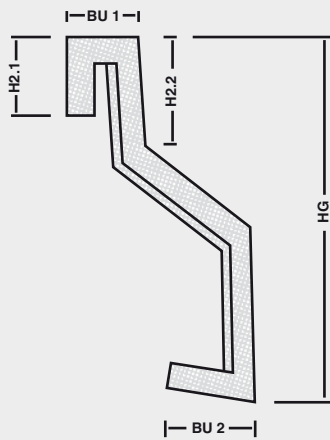

Forma • Shape • Form • Forme 7.2

**PROTEZIONE TELESCOPICA PER TORNIO TIPO 1**  
**LATHE MACHINE WAY COVER TYPE 1**  
**TELESKOPABDECKUNG FÜR DREHMASCHINE TYPE 1**  
**PROTECTEUR TELESCOPIQUE POUR TOUR TYPE 1**

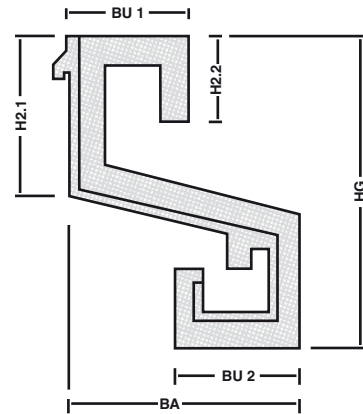

Forma • Shape • Form • Forme 7.1

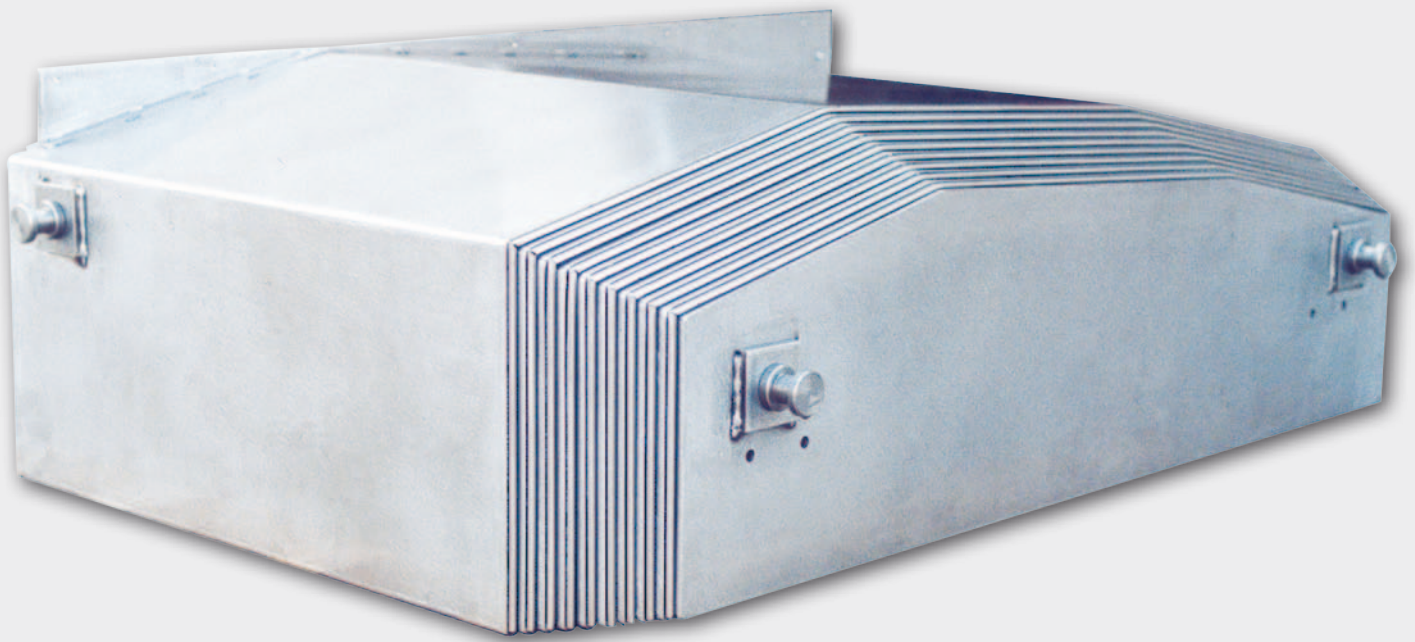
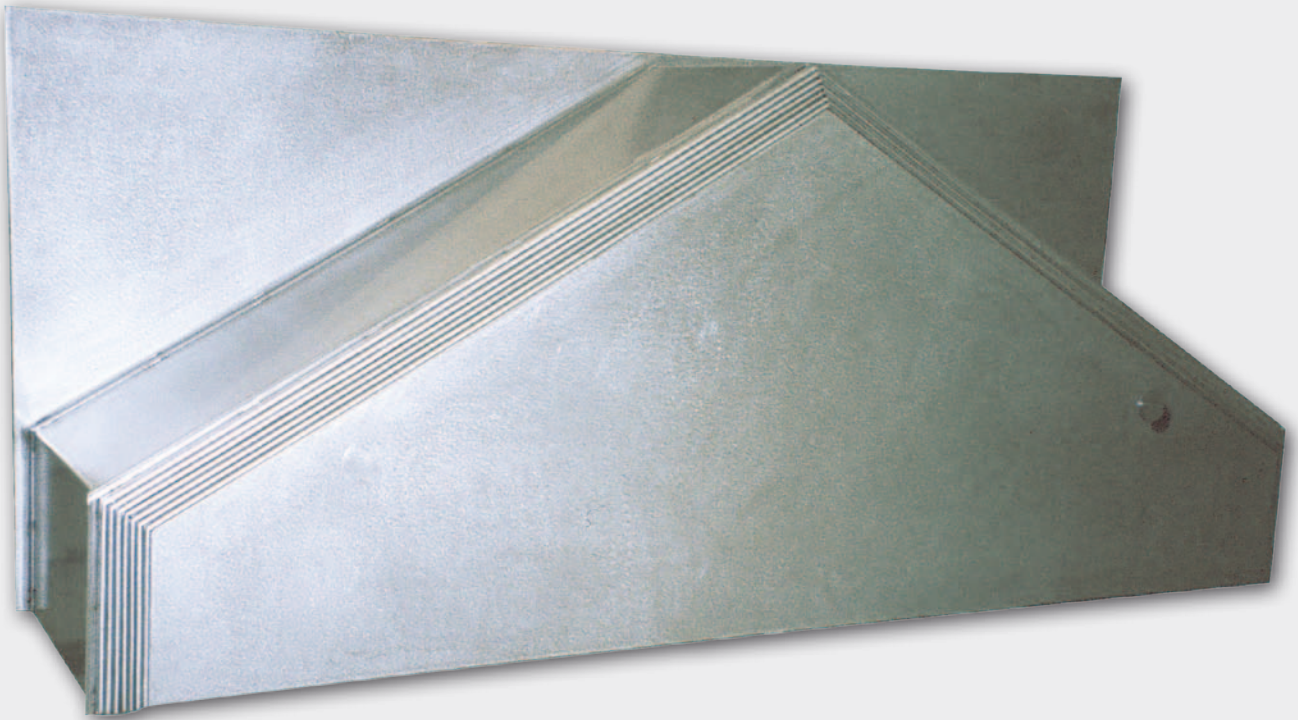

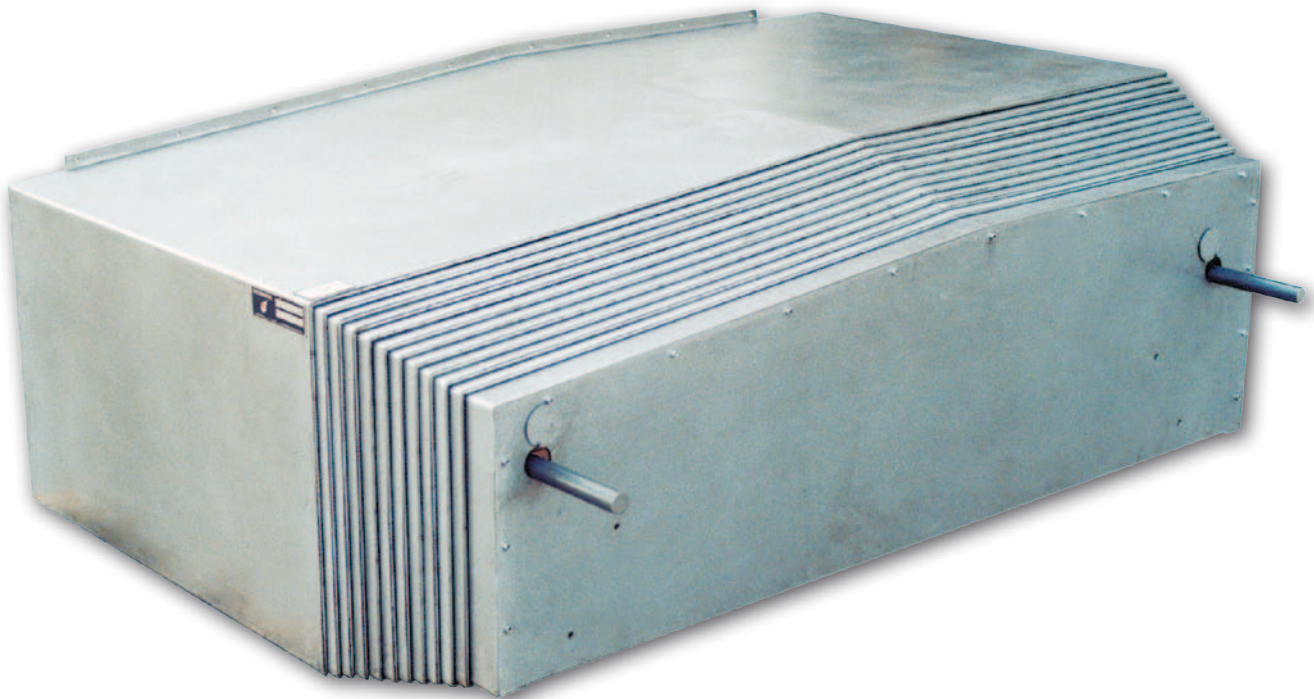

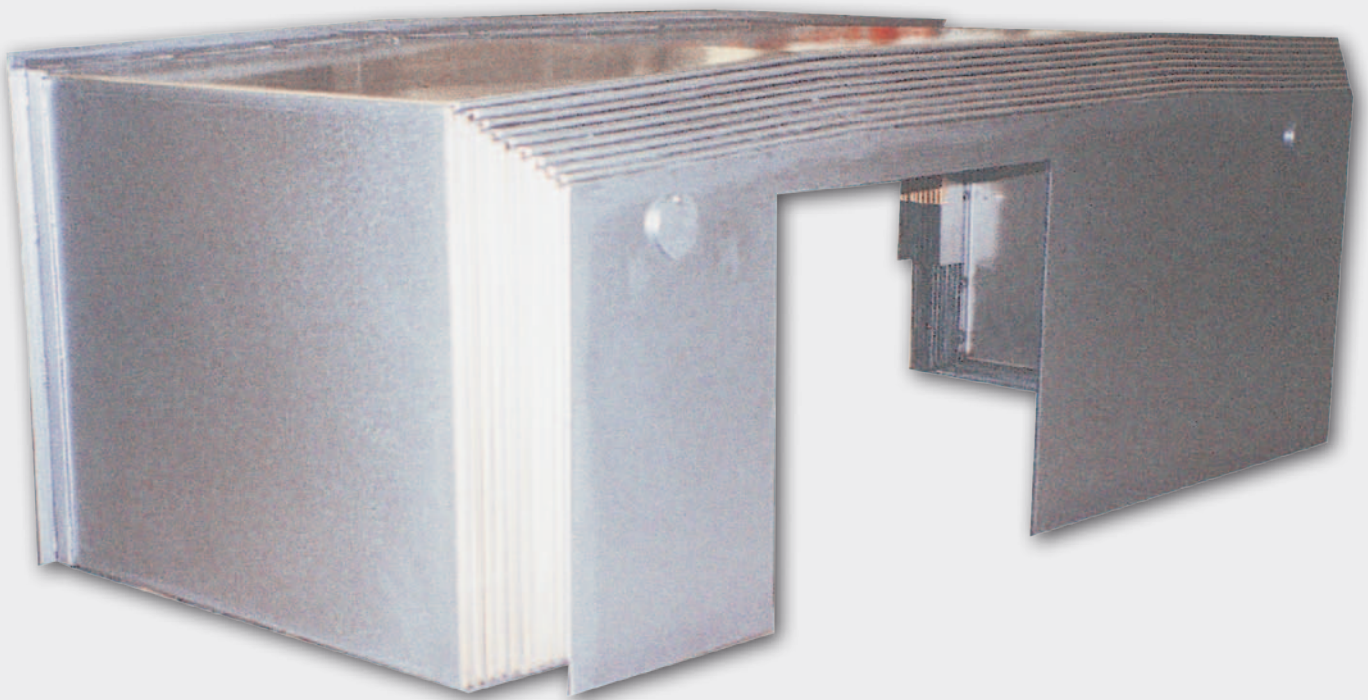
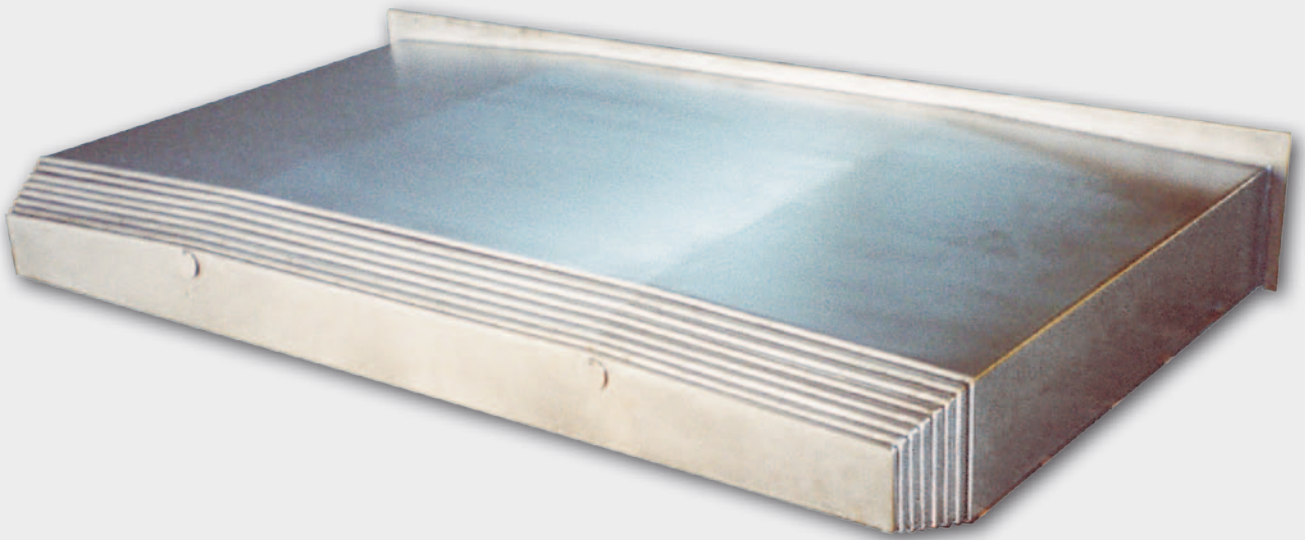

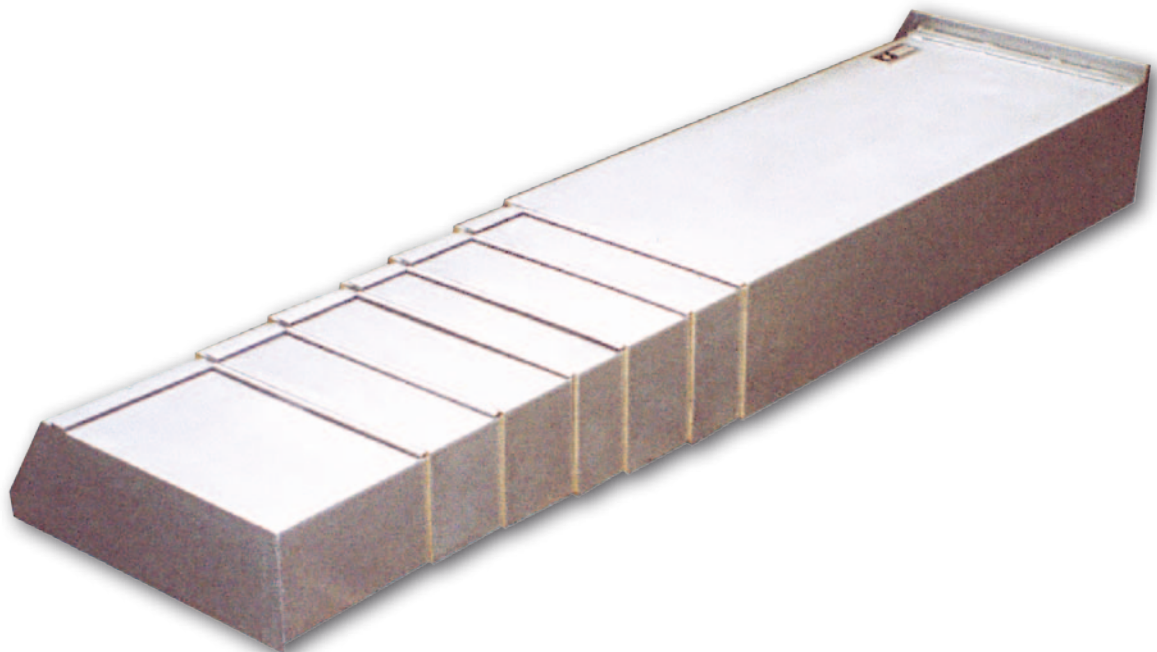
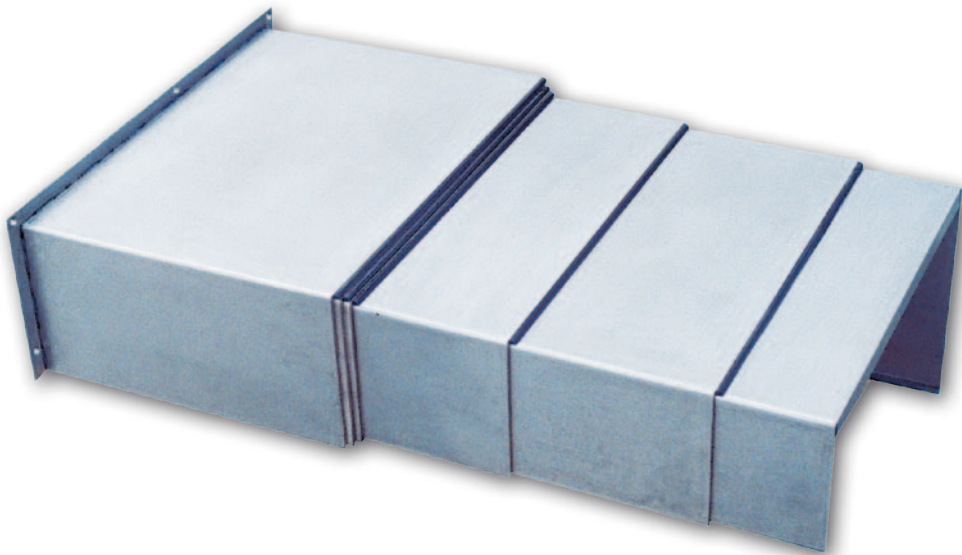
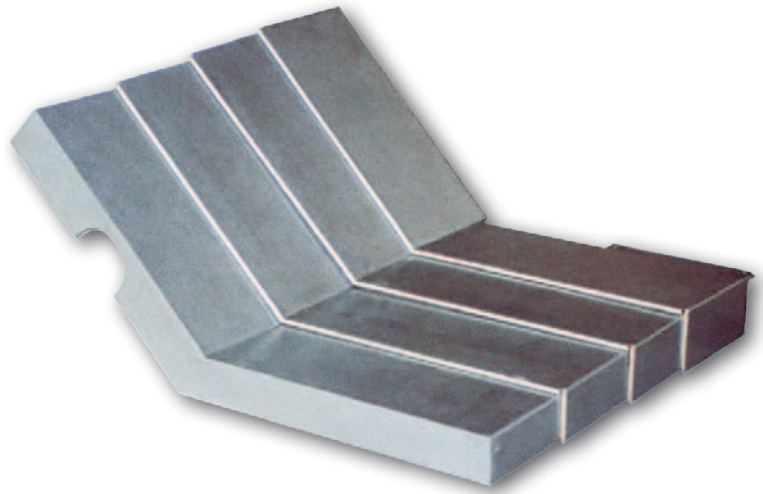

# PROGRAMMA DI VENDITA

SALES PROGRAMME

LIEFERPROGRAMM

PROGRAMME DE VENTE

Protezioni a soffiutto

Bellows

Balgenabdeckungen

Soufflets de protection

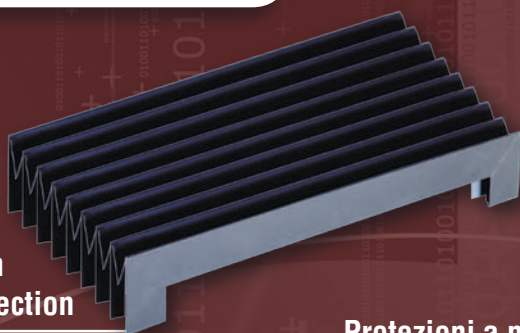

Protezioni a nastro

Roll Up covers

Rollo abdeckungen

Protecteurs à bande

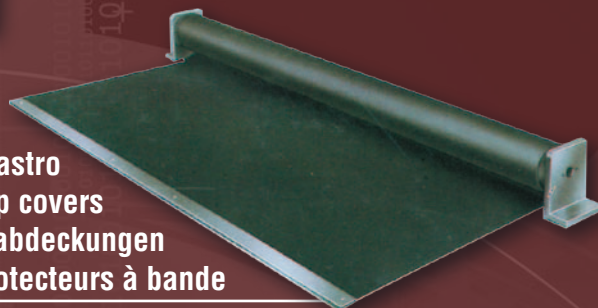

Convogliatori di Trucioli

Chip conveyors

Späneförderer

Convoyeurs à copeaux



Raschiaolio

Way wipers

Abstreifer

Racleurs de glissières

Molle a spirale

Helical metal spring guards

Teleskop-federn

Ressorts helicoidaux



Catene portacavi

Cable carriers

Energieführungsketten

Chaînes porte-cables



# TECNIMETAL

26037 SAN GIOVANNI IN CROCE (CR) | ITALY

Tel. +39 0375 310082 r.a. Fax +39 0375 91538

www.tecnimetal.com | e-mail: info@tecnimetal.com